

SEE PAGE 2 FOR
TOOL-HOLDER
DETAILS

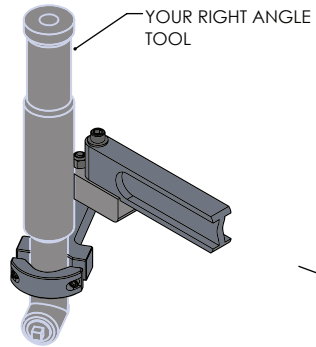

WORK AREA

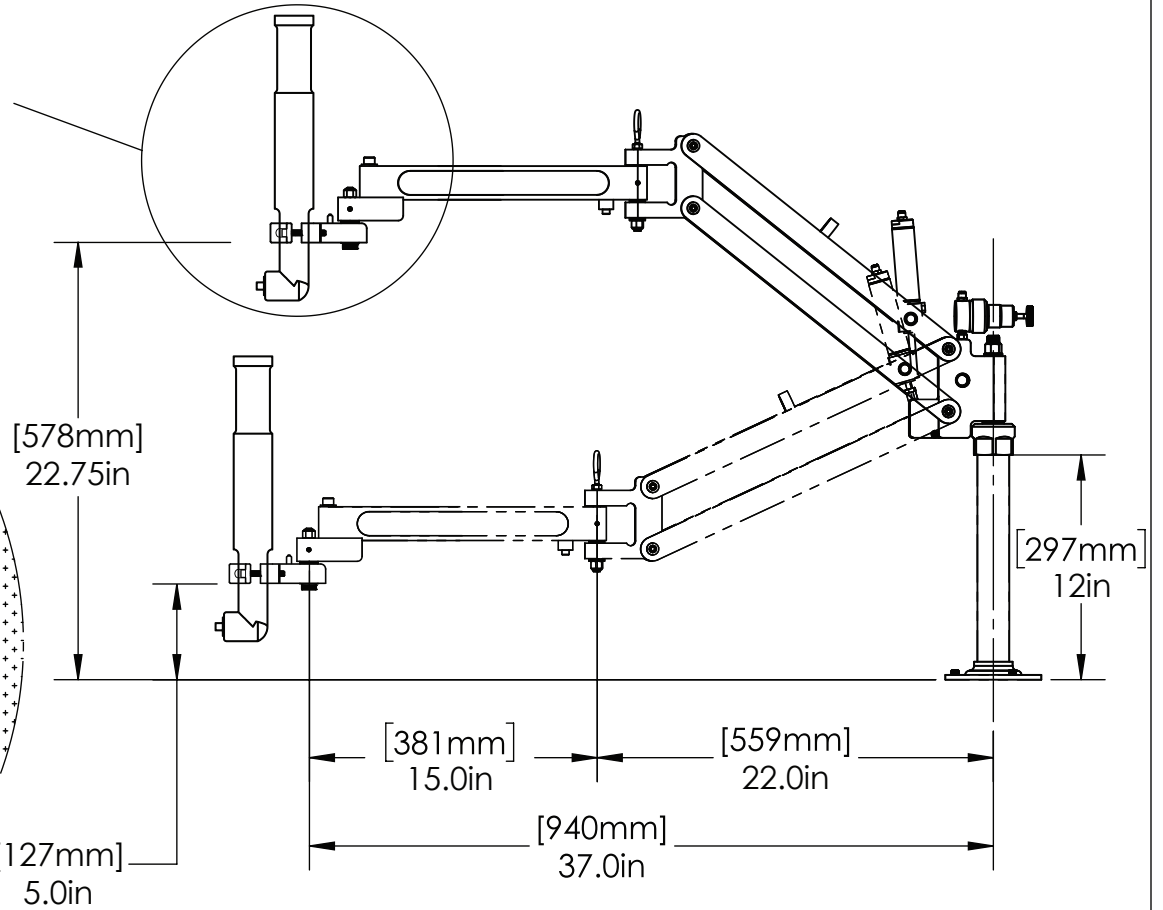
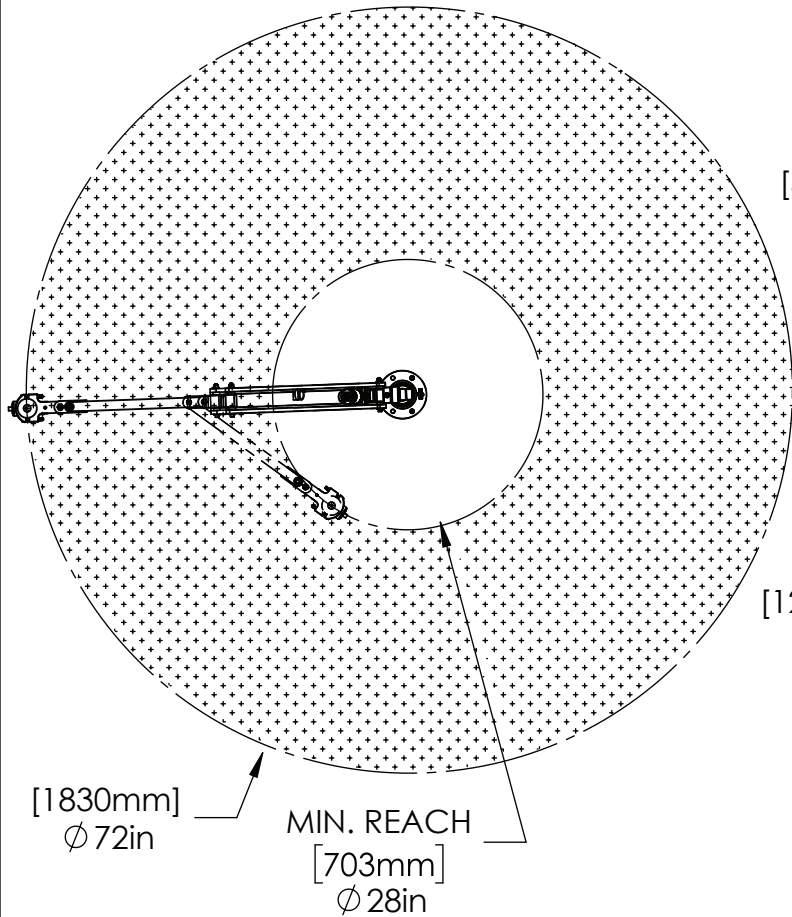

MODEL#: PA806-SRA

TOOL HOLDER INCLUDED, SRA-TH

For HORIZONTAL Fastening with customer's
Right Angle Air-Tool.

MAX TORQUE: 400 in-lbs (45 Nm)

MAX TOOLING WEIGHT: 4.5 LBS (2.0 KG)

COPYRIGHT © 2023 ERGONOMIC TOOL ARMS, LLC

www.toolarms.com

ETA
Ergonomic Tool Arms, LLC

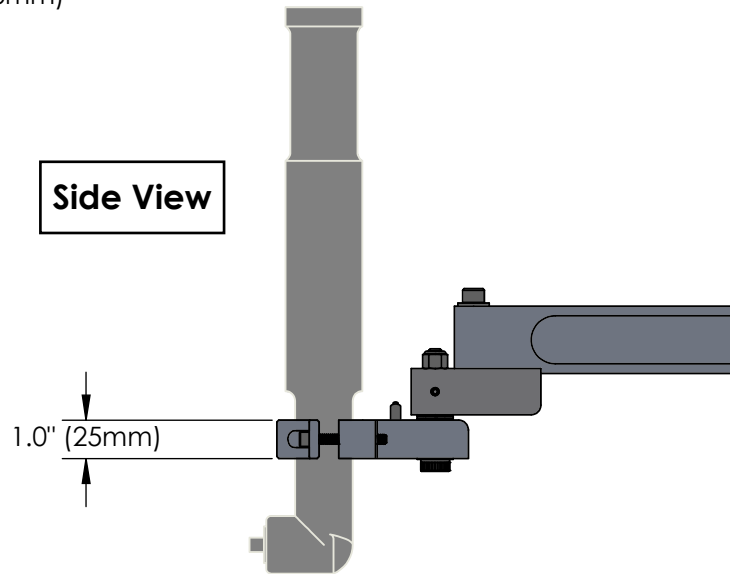
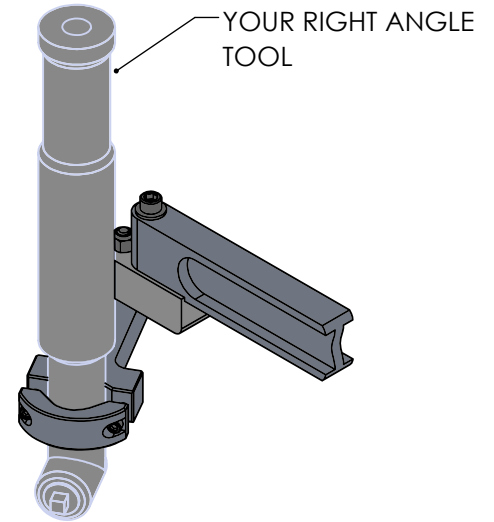
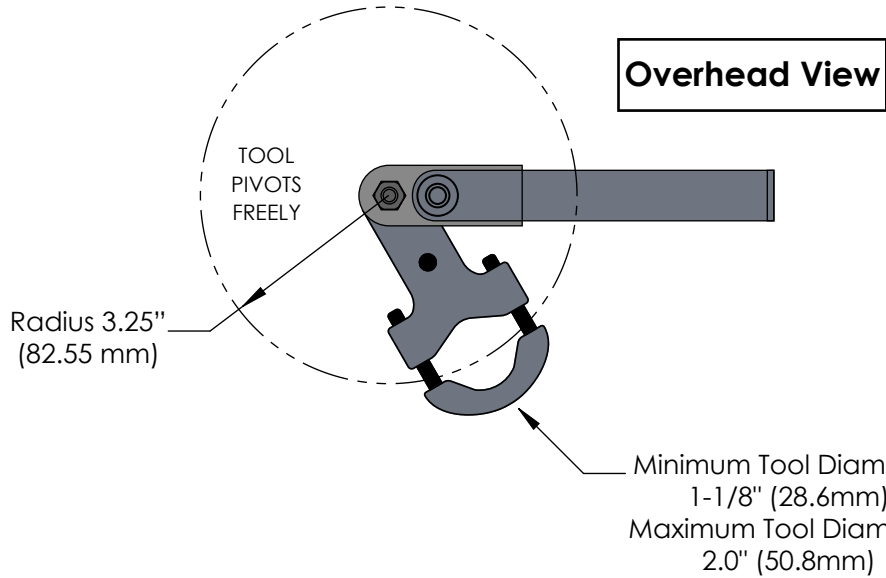

www.smart-arms.com



Model **SRA-TH** Simple **Right Angle Tool Holder** – For Horizontal Fastening

The SRA holds your right angle tool handle upward and allows it to swing freely 280 degrees for easy axial alignment with your fasteners. The SRA will clamp any tool body diameter from 1 1/8" to 2.0" (28.6 to 50.8mm).